

SILENCER<sup>co</sup>

# SWITCHBACK 22

---

FIELD MANUAL



# Warning

Failure to follow installation and maintenance instructions detailed in this manual may result in serious personal injury and damage to the weapon. Firearm sound suppressors are user-attached firearm muzzle devices, and as such, are subject to improper attachment issues unless the procedures outlined in this manual are followed precisely. Do not attempt to use this product unless you have specific training and experience in the use of firearms.

Before installing or removing the Switchback 22 sound suppressor from the host weapon, be sure that the weapon is unloaded and the action is opened so that it is visibly clear of any ammunition. If you are at all unsure

as to the proper procedures to ensure that your firearm is unloaded, please consult your firearm user's manual/instructions and contact a properly licensed dealer or the manufacturer of your weapon.

Because suppressed firearms make less noise than unsuppressed firearms, it is easy to forget that they are still firearms and capable of causing bodily injury and property damage. It is of vital importance to remember that a suppressed firearm is just as dangerous as an unsuppressed firearm, and that the same safe handling requirements still apply.

When removing the Switchback 22, use extreme caution as it may be hot to the touch after firing. Use gloves to avoid burns or other injuries.

Check the fit between barrel and suppressor before firing! The thread mount must be fully shouldered on the barrel. There should be no visible gap between the barrel shoulder and the face of the suppressor thread mount. If there is any gap DO NOT fire the host with the suppressor attached. Poor accuracy and product damage may result if the suppressor is not fully shouldered.

Assembly and disassembly should never be performed while the suppressor is affixed in any manner to a host firearm. Always completely remove the Switchback 22 from the host firearm before assembly and/or disassembly is attempted.

Before performing maintenance, removing, or installing the suppressor, open the action, ensure firearm is unloaded, and be sure the chamber is empty. Failure to do so can result in property damage, injury, or death.

# Overview

The Switchback 22 is the most versatile rimfire silencer ever developed. Not only does its modular construction allow the end user to choose from three lengths, but its long configuration can be optimized for either a pistol or rifle host.

Inspired by technology used in rocket diffusers, the modular baffles of the Switchback 22 are highly configurable. Arrange your Switchback 22 in the short pistol silencer configuration, or flip the baffles in the long configuration for industry-leading rimfire rifle sound suppression.

The Switchback 22 delivers the quality and versatility you have come to expect from SilencerCo's premium rimfire silencers including compatibility with a variety of cartridges, durability, user serviceability, and our industry

leading lifetime warranty and customer service.

Due to the notoriously harsh nature of rimfire ammunition, this product features CTA™ (Click Together Assembly) baffles to ensure the suppressor remains easy to clean—even after long days at the range.

The Switchback 22 mounts on conventional 1/2 X 28 (Class 3A) threads .400" in length.

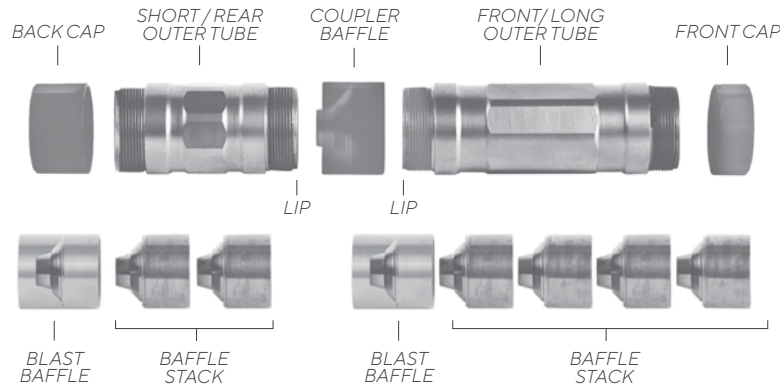

## Included

The Switchback 22 comes standard with (2) wrenches, (1) size 13 Viton O-ring already installed, as well as this field manual.

Also included is (1) thread spacer. The thread spacer is to be used on threads .600-.650.

### MATERIALS

**Baffles, Front Cap, & End Cap**—Stainless Steel  
**Tube**—Titanium

### DIAMETER

1.07"

### CALIBERS & RESTRICTIONS

.22 LR  
.17 Win Super Mag  
.17 HMR  
.22 WMR (.22 Win Mag)  
.22 Hornet  
5.7X28

**QUESTION ON THREAD DISTANCE**



LONG DEFAULT

RIFLE OPTIMIZED

MEDIUM

SHORT

## Sound Average

	LENGTH	WEIGHT	SOUND AVERAGE	
<b>SHORT</b>	2.50"	3.2 OZ	142.4 dB Pistol / 125.8 dB Rifle	
<b>MEDIUM</b>	3.59"	4.3 OZ	128.5 dB Pistol / 117.9 dB Rifle	
<b>LONG</b>	5.75"	6.4 OZ	114.0 dB Pistol <sup>1</sup> / 108.0 dB Rifle <sup>2</sup>	<sup>1</sup> Default Configuration <sup>2</sup> Rifle Optimized Configuration

**Sound measurements** taken on 16" barrel bolt action rifle and a 3.3" barrel semi-automatic pistol, using ASA standard testing methods with 22LR CCI Standard Velocity Ammo



NEED PIC TO SUPPORT COPY

## Assembly & Modularity

### THREADING & UNTHREADING

Altering configurations of the Switchback may include tightening and loosening of several threaded parts.

All threads are standard right-hand. When tightening, snug the parts together slightly more than hand-tighten pressure using a single provided wrench. Ensure threads and shouldering surfaces are clean and free of debris. Don't over tighten.

To loosen, seat the spanner wrench in your left hand on the part you wish to unthread, and your right hand on the silencer body. Push the handles of the two spanner wrenches towards each other.



### Default Configuration

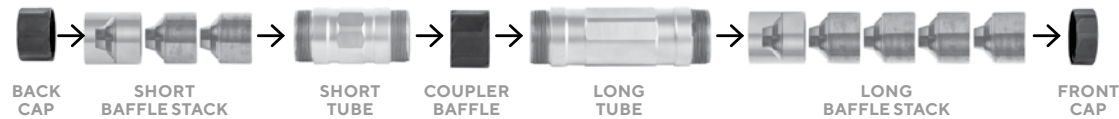

### Short Configuration



### Medium Configuration

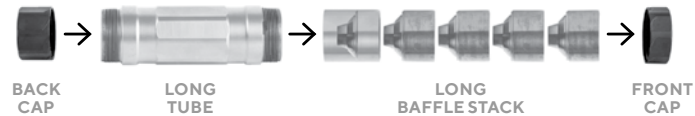

### Rifle Optimized Configuration

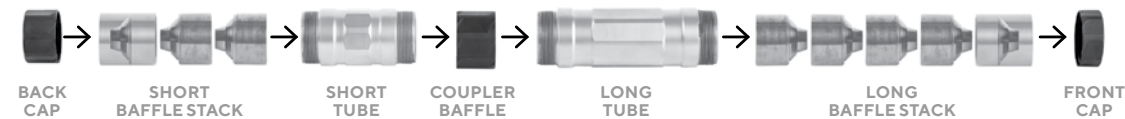

## Default Configuration *QUICK REFERENCE*

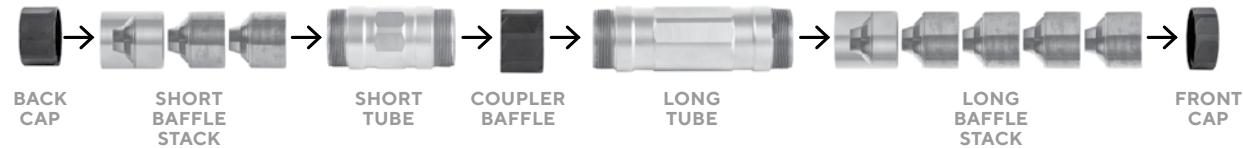

### DEFAULT CONFIGURATION

Thread tubes into coupler baffle with the baffle cone toward the short (rear) tube as seen to the right. Lipped ends of outer tubes face inward towards the coupler baffle for easy baffle alignment in next step. Gently snug the tubes and coupler baffle together with the provided wrenches before inserting any baffles. Excessive force is not necessary.

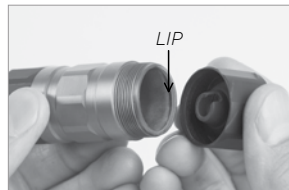
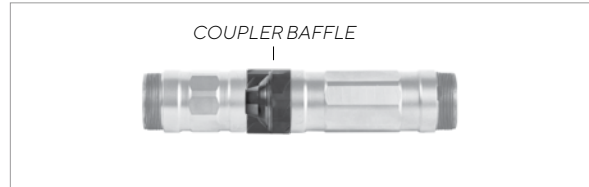

## Default Configuration *CONTINUED*

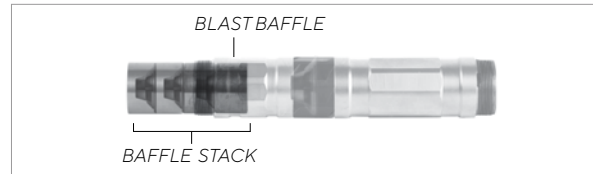

Slide the baffles from step 2 into the short tube oriented as seen in the image to the left.

For best sound performance, align the cutouts of the baffle stack with the cutout of the coupler baffle. Seal the baffles inside with your serialized back cap. Gently tighten with your provided wrenches.



**CORRECT**



**INCORRECT**

In similar fashion, assemble the remaining blast baffle, and baffles oriented as seen to the right. Insert the baffle stack into the front tube, again visually aligning the cutouts to the coupler baffle for best performance. Gently tighten the front cap down with provided wrenches.

**READY FOR USE**





## Medium Configuration *QUICK REFERENCE*

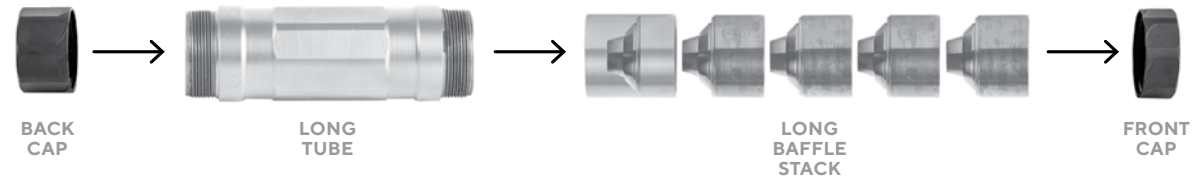

Using only the long tube, thread your serialized back cap on one side, and front cap on the other with the baffles oriented as shown on the right. Tube orientation (which side the lip is on) does not matter in this configuration.

**READY FOR USE**



## Short Configuration *QUICK REFERENCE*

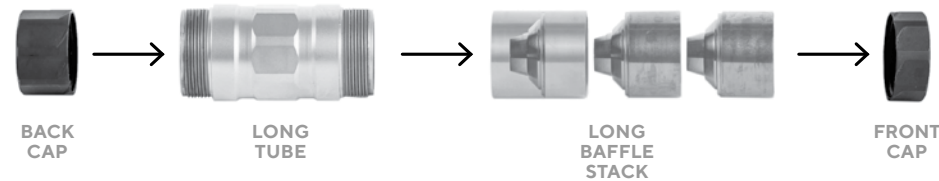

Using only the short tube, thread your serialized back cap on one side, and front cap on the other with the baffles oriented as shown on the left. Tube orientation (which side the lip is on) does not matter in this configuration.

**READY FOR USE**



## Rifle Optimized Configuration *QUICK REFERENCE*

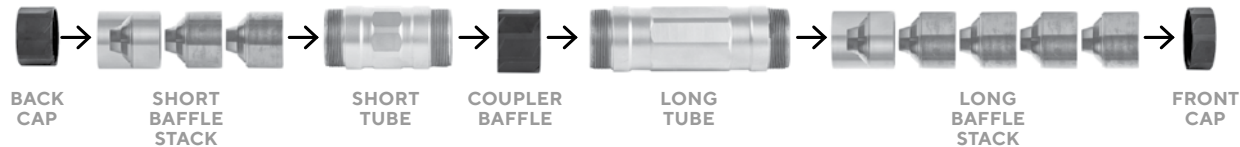

Assembly is the same as Default Configuration with the forward baffle section reversed as shown to the right.

You may also remove the front cap and flip the entire front module (long outer tube with the baffles inside) to avoid touching lead if internals are already fouled. Replace the front cap and tighten gently with provided wrenches. The cutouts may not align, which is ok in this configuration.

**READY FOR USE**



# Maintenance

The user-serviceable nature of the Switchback 22 makes cleaning quick and simple. It is recommended to clean the Switchback 22 every 1,000 rounds. Cleaning should also be performed when switching between .22 LR and 5.7x28mm or after the silencer has been shot with an ablative media.

**WARNING** *The majority of fouling in 22 suppressors is lead and is highly toxic. Severe health problems can result from lead entering the body not only from ingestion (e.g., eating with exposed hands after handling lead), or even simple acts such as rubbing your eyes after handling ammunition. Exercise extreme caution when cleaning your suppressor, as you will be handling a substantial amount of lead. Wear nitrile gloves and wear protective eyewear at all times, handle your components in a secure area, and thoroughly wash your hands with soap and cold water immediately after handling.*

## TUBES

It is not recommended to blast, dip, or ultrasonic clean the outer tubes, as it may damage them. Due to the self containing/sealing baffles no significant fouling should be present inside the outer tubes. The outer tubes can be easily cleaned or wiped out with a soft brush with plastic bristles, paper towel, or rag. There may be trace lead buildup on the internal diameter of the lip of the silencer outer tubes which can easily be broken off and removed by hand, or cleaned off with a soft brush with plastic bristles.

## BAFFLES, FRONT CAP, & BACK CAP

Disassemble the Switchback 22 as listed in the instructions and clean using the following suggested products. Dry all components thoroughly before reassembling. If using a water-based cleaner, be sure to lightly coat the baffles with oil or other corrosion-resistant product after cleaning.

*The aluminum tube, front cap, and spring retainer should NOT be soaked in chemicals or used in an ultrasonic cleaner due to the potential for damage to the finish and the **potential to erase the serial number** due to reaction with the aluminum tube. We recommend using a damp cloth or non-abrasive brush to gently wipe or scrub away debris.*

**CLEAN BACK CAP BY HAND TO AVOID ERASING SERIAL NUMBER?**

CONTINUED ON NEXT PAGE

---

# Maintenance *CONTINUED*

## SCRUBBING

Various gun cleaning solvents and general CLP (cleaner/lubricant/protectant) gun oils can be used to help break up the fouling on your baffles. Utilizing a nylon brush,

q-tips, and rags or paper towels, etc, you can successfully clean your baffles with some time scrubbing. Abide by the safety precautions previously mentioned in this manual regarding lead at all times. Dispose of leaded materials in accordance with your local laws.

## BLASTING

Blasting with soda media is an excellent way to clean baffles and other components. A blast cabinet or handheld soda blaster is required for this method. DO NOT blast parts with glass bead, aluminum oxide, or other hard media; this will etch and damage your components. Note that your media will become exposed to lead during this process. Good containment, ventilation, gloves, and a breathing mask should be used to protect yourself and those around you from lead particulates that become airborne. Dispose of contaminated blast media appropriately and in accordance with local, state, and federal regulations.

## DIP

Paracetic Acid (AKA "The Dip") is an off-the-shelf 50/50 mix of 3% hydrogen peroxide and 5% acidity distilled white vinegar. It can be used to clean baffles and other stainless steel components very effectively, as it actually dissolves lead.

**WARNING** Do not use this on your Titanium Switchback tubes or nitrided parts, as it will cause corrosion. When Paracetic Acid reacts with lead, it results in Lead Acetate. This is toxic and is easily absorbed through exposed skin. Eye protection and impermeable gloves (such as disposable Nitrile gloves) must be worn at all times.

*CONTINUED ON NEXT PAGE*

---

## **Maintenance** *CONTINUED*

Simply let your fouled baffles soak in the mix. No scrubbing is needed. A glass jar or other chemical resistant container should be used to hold everything, as it is not only toxic, but very corrosive as well. Keep it in a well ventilated area away from any children, pets, or anyone/anything else that could otherwise come in contact with it.

Check on the components every few hours, or overnight, until the lead has been dissolved and your baffles are clean. Carefully remove

the components and rinse them off with clean water. Allow to dry and reassemble.

The resulting Paracetic Acid/Lead Acetate mix must be disposed of carefully and appropriately, in accordance with all local regulations. Contact your local waste disposal establishment for instructions on HAZMAT (hazardous material). Usually it is as simple as dropping it off at your local waste disposal establishment. Do not dump it down the

drain or dump it outside. It is very nasty stuff that is not only very toxic, but also corrosive and can potentially damage plumbing, or anything else it comes in contact with.

### **ULTRASONIC CLEANING**

Ultrasonic cleaning is a 50/50 mix of water and “Purple Power” cleaner and works very well for cleaning baffles. This method is not recommended for use on the outer tubes. Note that this solution will contain lead. Dispose of appropriately and in accordance with local, state, and federal regulations. DO NOT dump it down the drain or outside.

## Limited Lifetime Warranty

Silencerco, LLC (“**SilencerCo**”) warrants to you that if any product sold by SilencerCo and used for its intended use ever becomes defective, SilencerCo will repair or replace the product at no charge, other than shipping, subject to the conditions set forth below.

**THE WARRANTY EXTENDS ONLY TO THE ORIGINAL REGISTERED PURCHASER.** This warranty does not cover damage to our products or host firearm resulting from careless or irresponsible handling adjustments or modifications to its intended design, negligence, or other unforeseeable abuse. SilencerCo assumes no liability for unsafe or illegal use of the silencer by its purchaser or any other user that comes in contact with the product after purchase.

SilencerCo assumes no responsibility for physical injury or property damage resulting from careless or irresponsible handling or by any use contrary to the recommendations, warnings and cautions generally listed in this manual. SilencerCo does not cover damage to the silencer or host firearm resulting from improper “*hand-loaded, reloaded, previously used or otherwise defective ammunition.*” **THIS WARRANTY IS FURTHER REGULATED BY RELEVANT AND APPLICABLE STATE AND FEDERAL LAWS.**

If SilencerCo determines that you satisfy the conditions for warranty coverage under this limited warranty, SilencerCo will, at no charge, replace or repair the SilencerCo product with the same or similar

model subject to the terms herein. If no replacement is available, and SilencerCo determines that the product cannot be repaired, SilencerCo will replace your nonperforming or defective unit with a unit that, in SilencerCo’s sole determination, is substantially similar to your lawfully purchased and registered product. This warranty extends to any and all parts as originally sold by us, but **does not extend to any altered product or firearm that is altered or rebuilt after original purchase, damaged through abuse, misuse through lack of proper care and maintenance, or used other than for its legal intended purposes.**

SILENCERCO’S LIABILITY FOR BREACH OF ANY WARRANTY WITH RESPECT TO A SILENCERCO PRODUCT SHALL BE LIMITED TO REPLACING OR REPAIRING THE NONPERFORMING OR DEFECTIVE PRODUCT AS DESCRIBED IN THIS LIMITED WARRANTY. THIS LIMITED WARRANTY SHALL BE YOUR SOLE AND EXCLUSIVE REMEDY WITH RESPECT TO A NONPERFORMING OR DEFECTIVE PRODUCT, AND SILENCERCO WILL NOT BE LIABLE FOR ANY OTHER DAMAGES, INCLUDING DIRECT, INCIDENTAL OR CONSEQUENTIAL DAMAGES OR DIMUNITION IN VALUE DUE TO REPAIR OR REPLACEMENT WITH A DIFFERENT PRODUCT.

For assistance with repairs, please contact our consumer service department at **801-417-5384**.

# Register Your SilencerCo Product Online To Activate Your Lifetime Warranty

**SILENCERCO.COM/REGISTER**



Protect Your Rights | Protect Your Hearing

The American Suppressor Association is fighting to protect and expand your silencer rights. Join the fight today!

**AMERICANSUPPRESSORASSOCIATION.COM**

**FOR QUESTIONS, CONTACT OUR CUSTOMER SERVICE TEAM  
AT 801.417.5384 OR INFO@SILENCERCO.COM**

© 2019 SilencerCo, LLC. All Rights Reserved. The contents of this publication may not be reproduced in any form or by any means in whole or in part without the prior written permission of the copyright owner.



DESIGNED &  
MANUFACTURED  
IN THE USA

**SILENCERCO.COM**